

HIDROMOTORJI MP

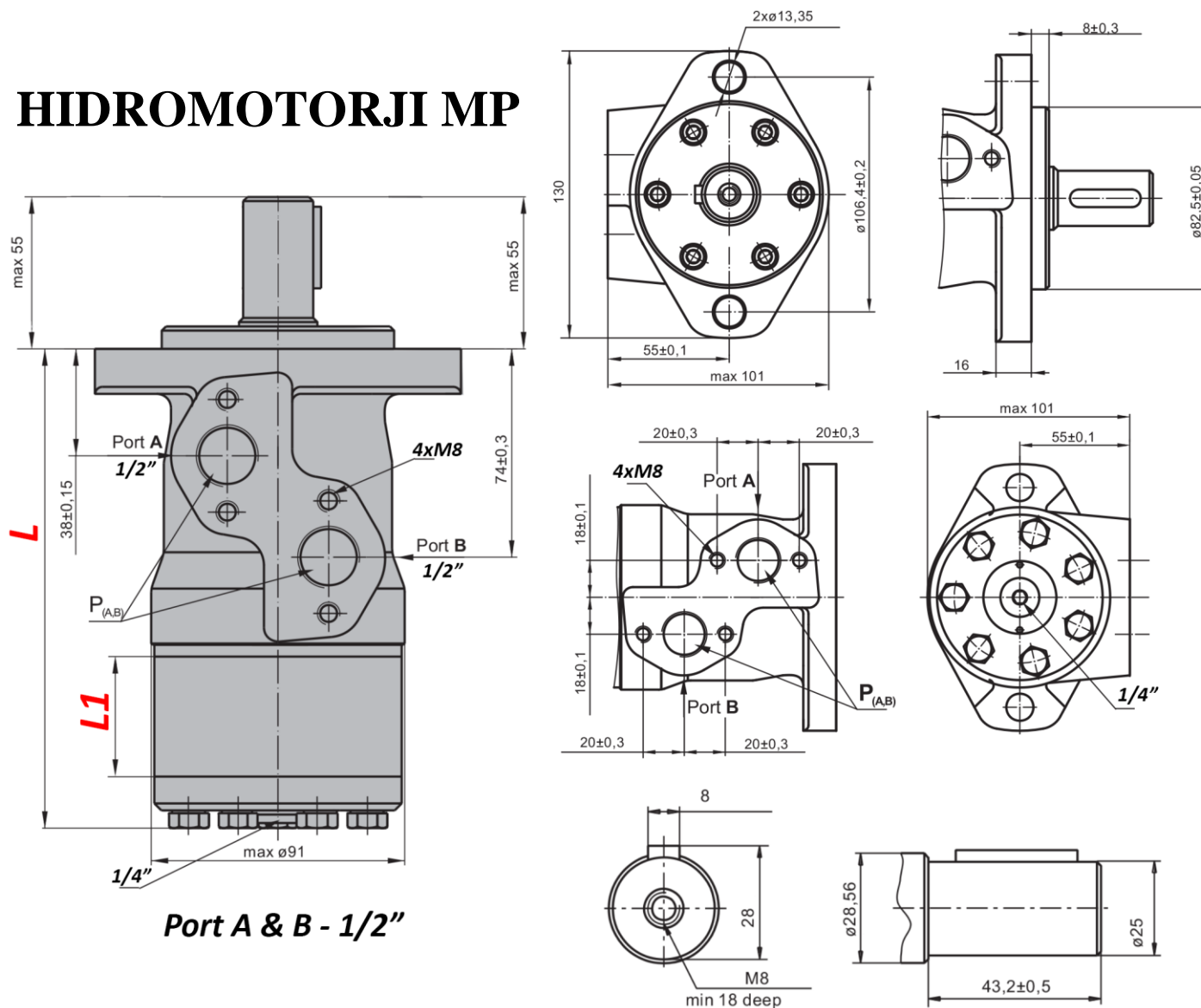

Port A & B - 1/2"

	L [mm]	L1 [mm]
MP 40	136,5	7,4
MP 50	135,5	6,67
MP 80	139,5	10,67
MP 100	142	13,33
MP 125	145,5	16,67
MP 160	150	21,33
MP 200	155,5	26,67
MP 250	162	33,33
MP 315	171,5	42,67
MP 400	182	53,33

		MP 40	MP 50	MP 80	MP 100	MP 125	MP 160	MP 200	MP 250	MP 315	MP 400
cm/vrtljaji		40	49,5	79,2	99	123,8	158,4	198	247,5	316,8	396
Vrtljaji [rpm]	konstantni	1500	1210	755	605	486	378	303	242	190	150
	s prekinitvami	1750	1515	945	755	605	472	378	303	236	189
Navor [Nm]	konstantni	6,2	9,4	15,1	19,3	23,7	31,3	36,6	38	38	36
	s prekinitvami	8,2	11,9	19,5	23,7	29,8	37,8	45,6	58,3	56	59
	max.	10,7	14,3	22,4	27,5	36,5	43,8	55	68,5	85	85,4
Moč [kW]	konstantna	8,4	10,1	10,2	10,5	10,2	10,1	10	7,5	5,8	4,6
	s prekinitvami	11,6	11,2	12,5	12,8	12	12,1	12	12	9	7,8
Tlak [bar]	konstantni	120	140	140	140	140	140	135	110	90	70
	s prekinitvami	155	175	175	175	175	175	160	160	140	115
	max.	225	225	225	225	225	225	225	225	225	180
Pretok olja [L/min]	konstantni	60	60	60	60	60	60	60	60	60	60
	s prekinitvami	75	75	75	75	75	75	75	75	75	75
Priključni navoj		1/2"	1/2"	1/2"	1/2"	1/2"	1/2"	1/2"	1/2"	1/2"	1/2"
Teža [kg]		5,7	5,8	5,9	6,1	6,2	6,4	6,6	6,8	7,1	7,6

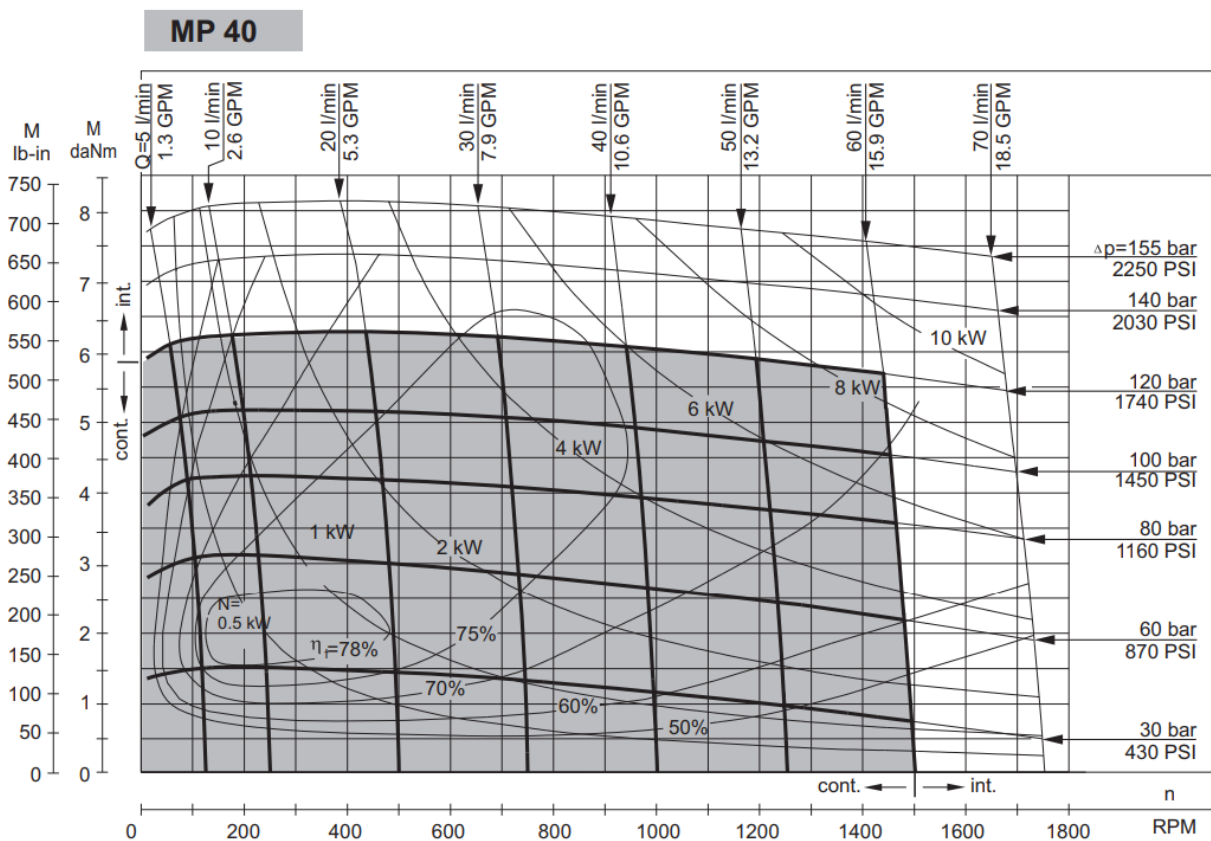

MP 50

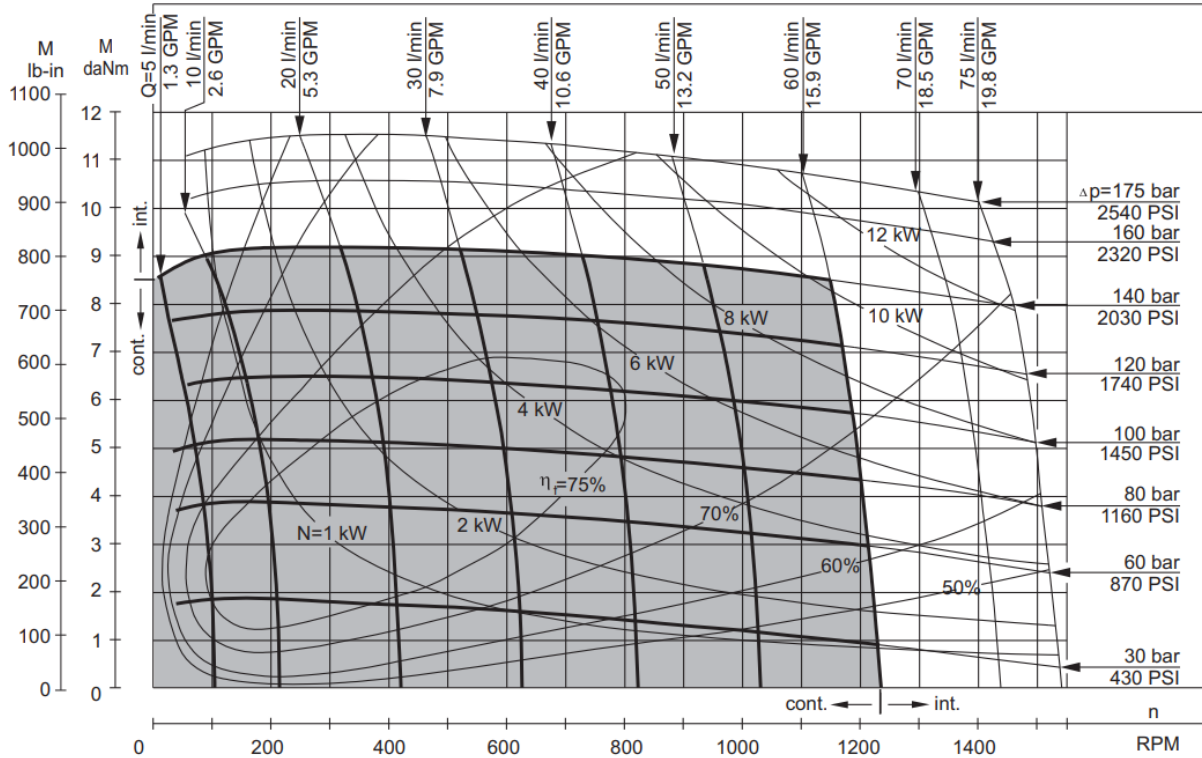

MP 80

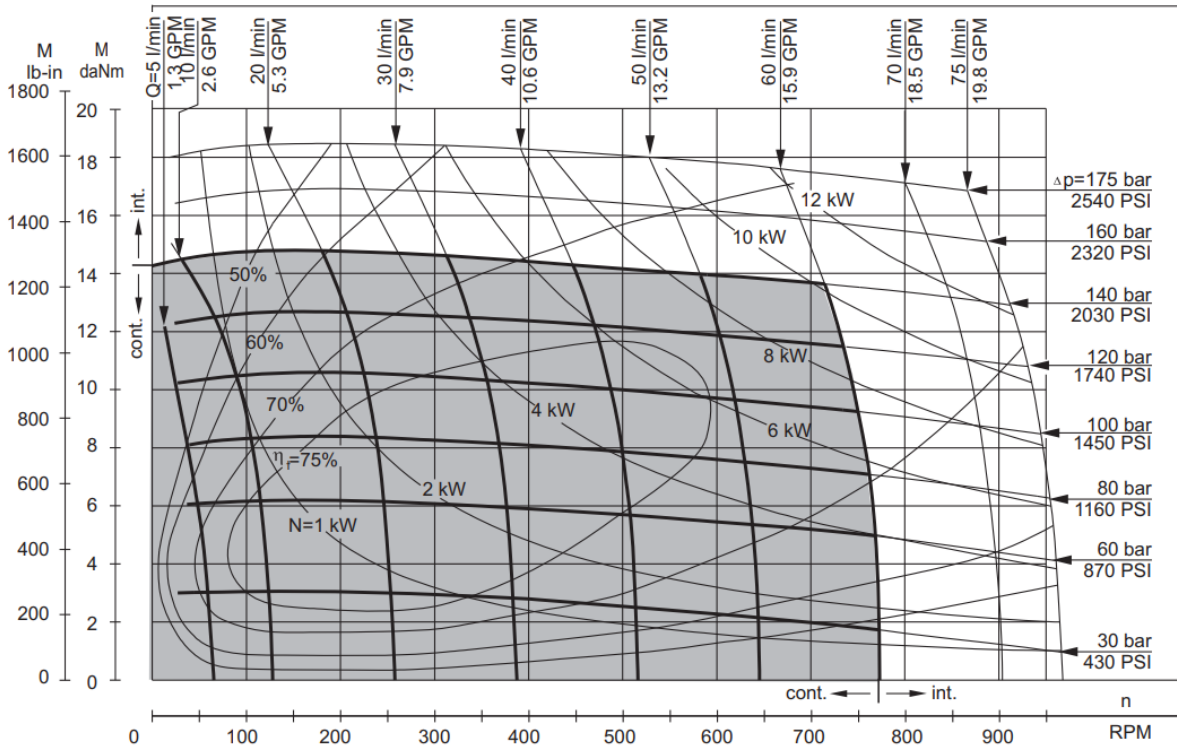

MP 100

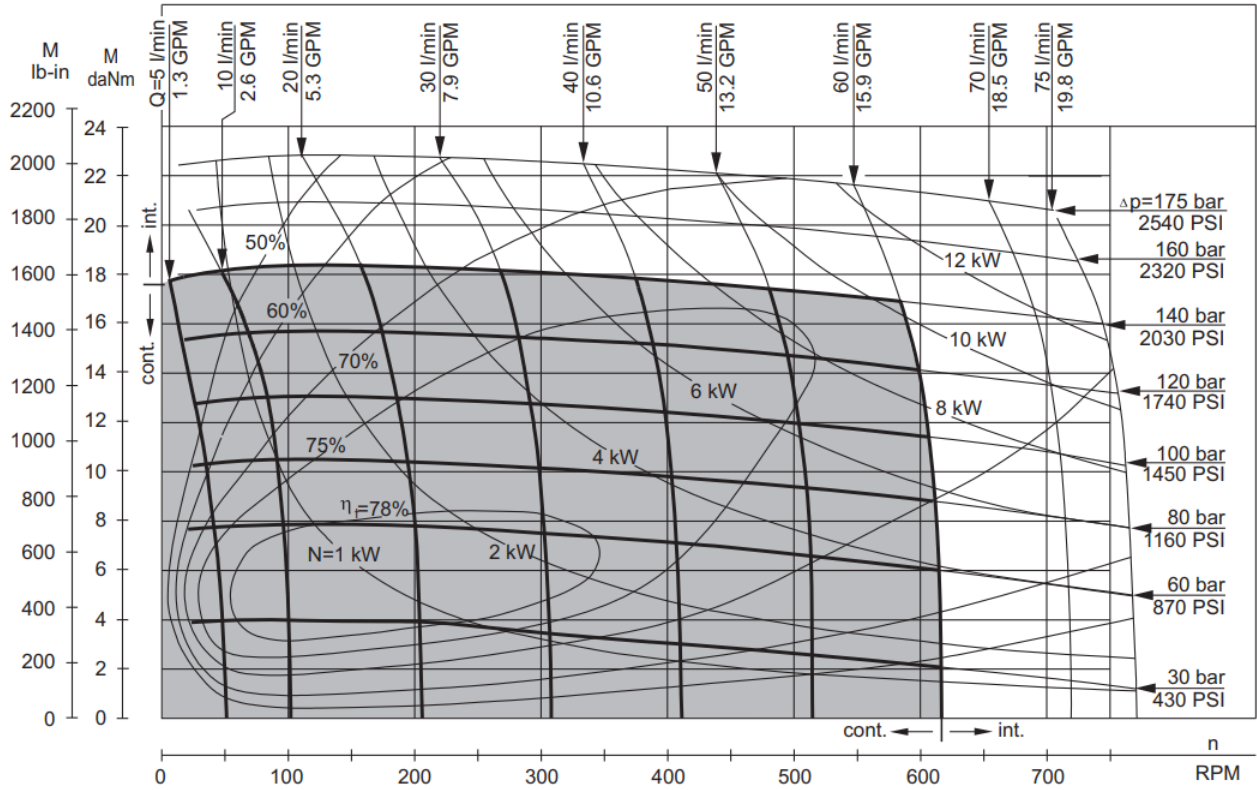

MP 125

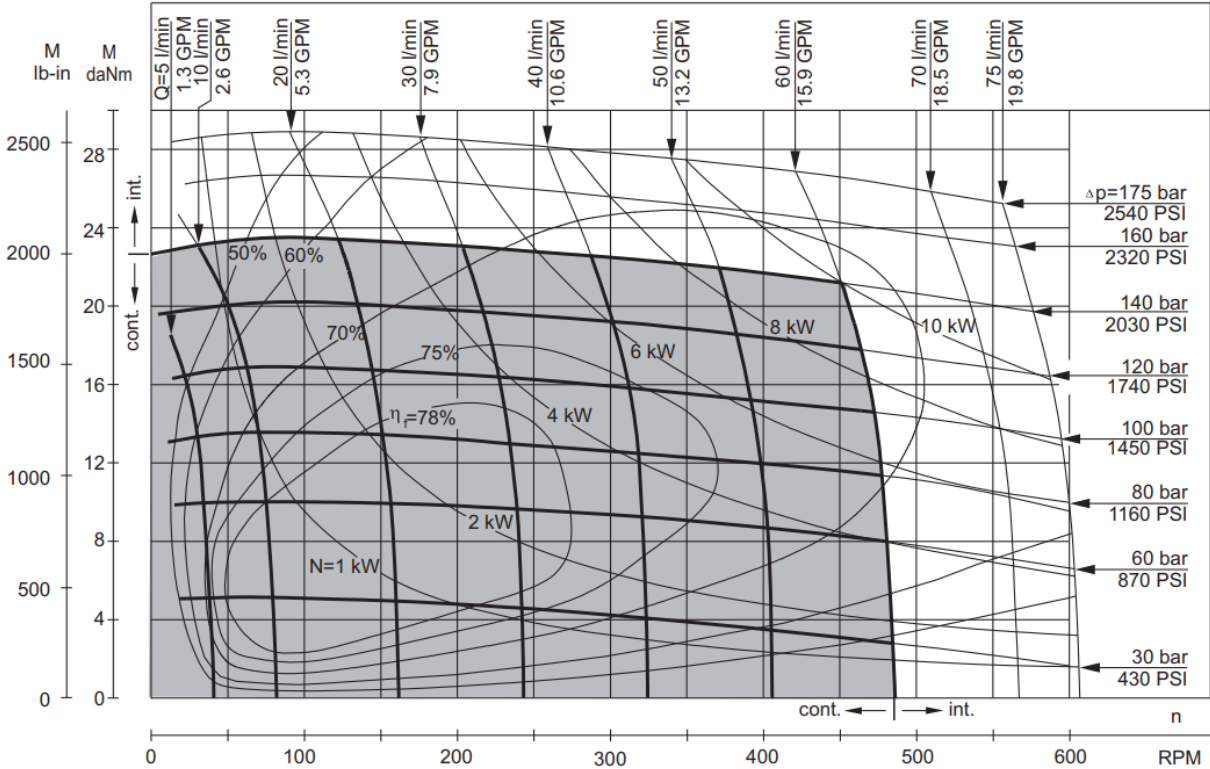

MP 160

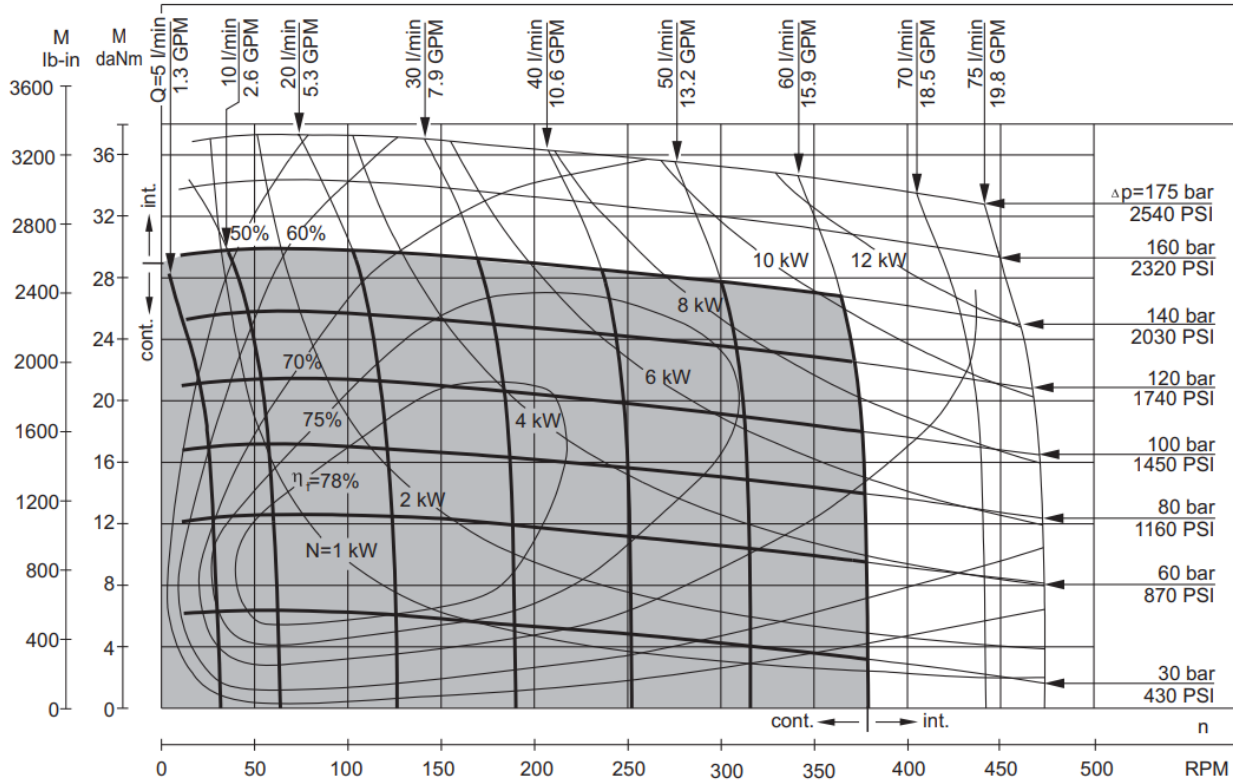

MP 200

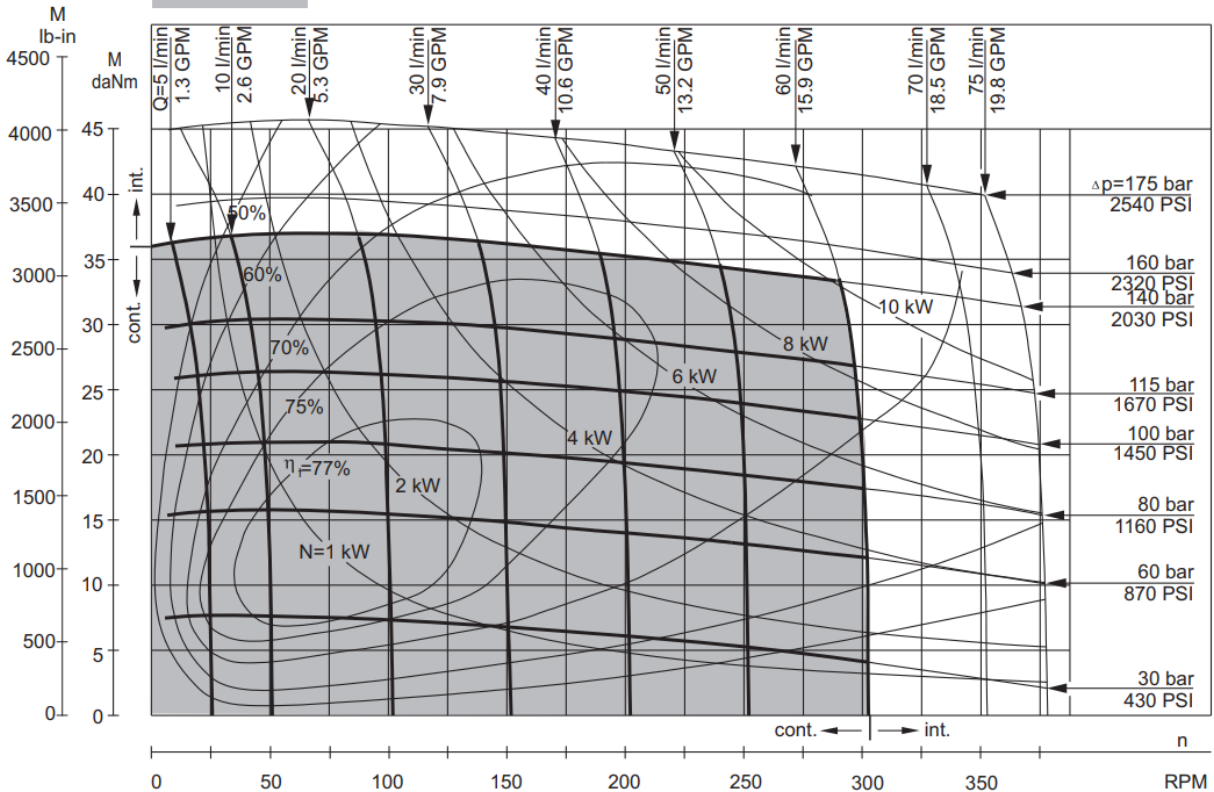

MP 250

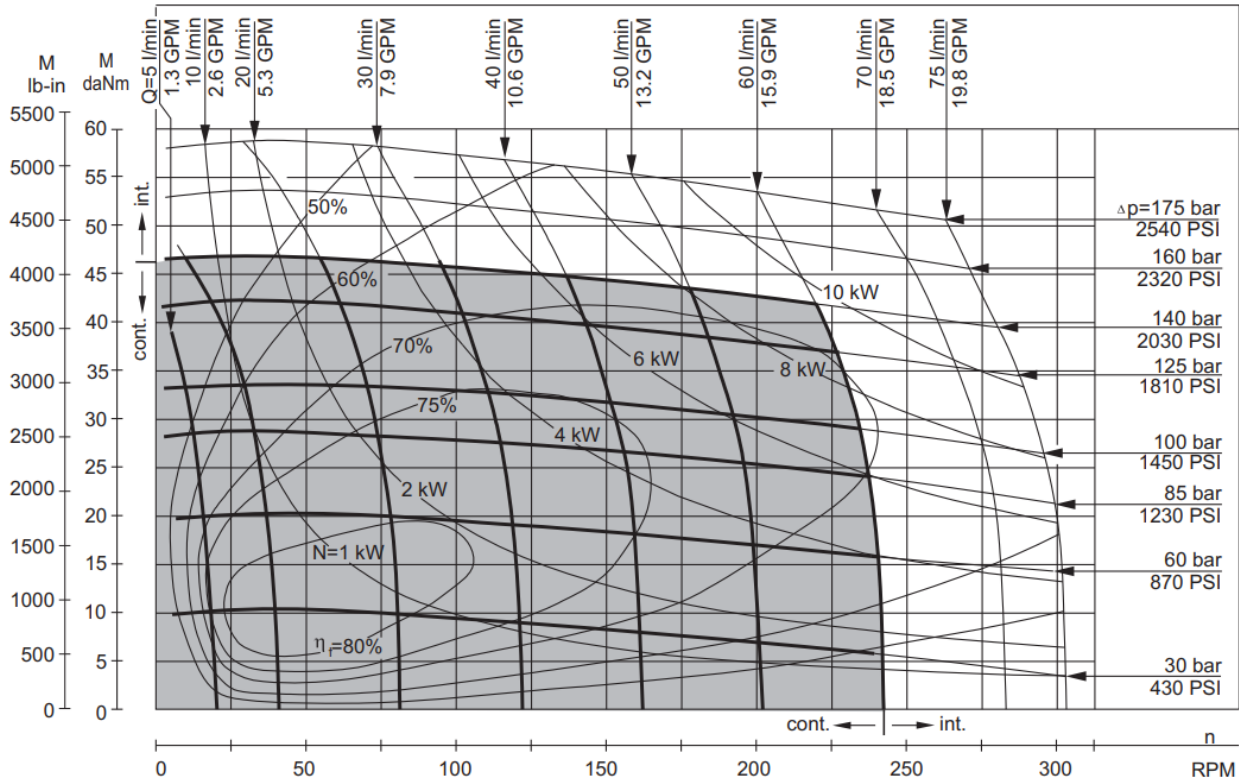

MP 315

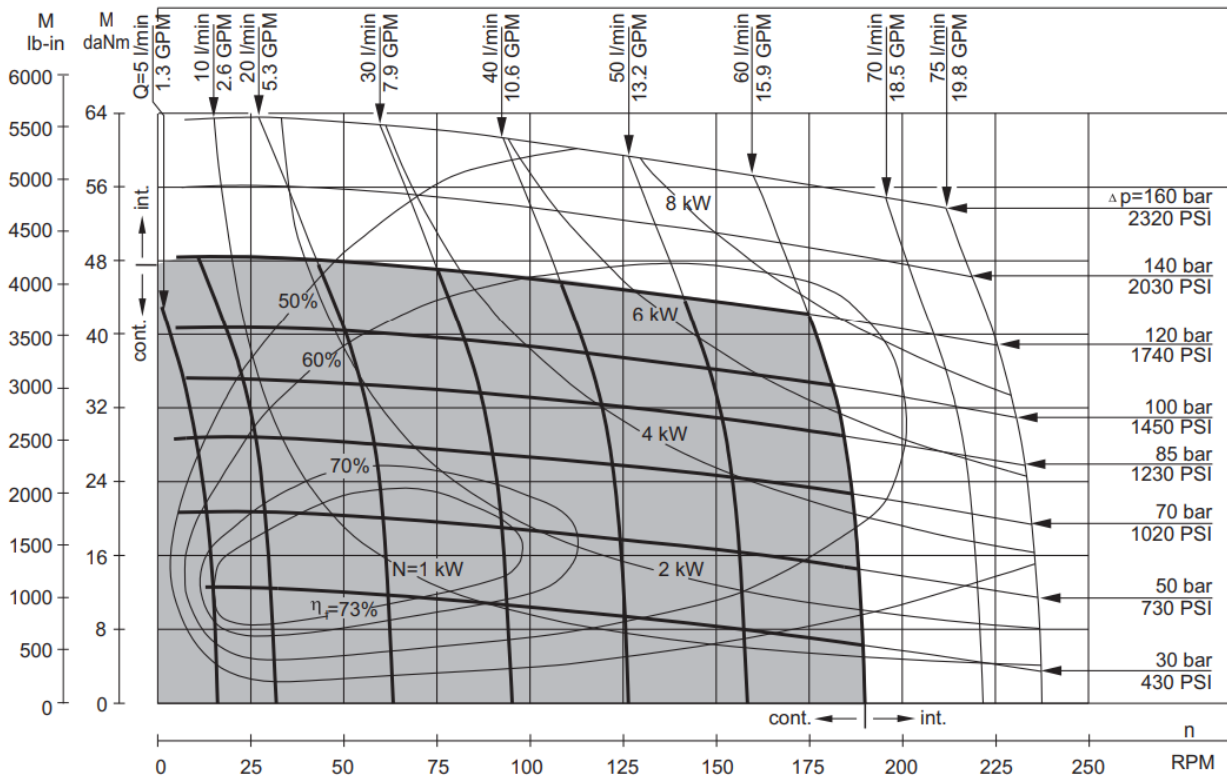

MP 400

